

Frequency response

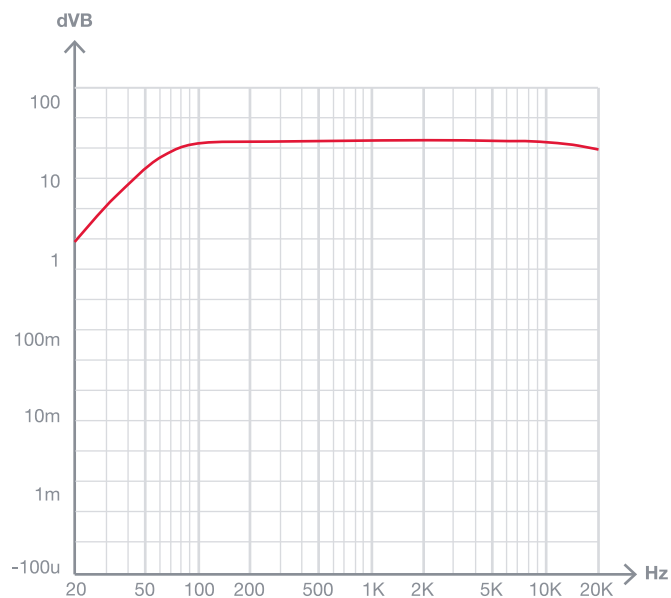

Block diagram

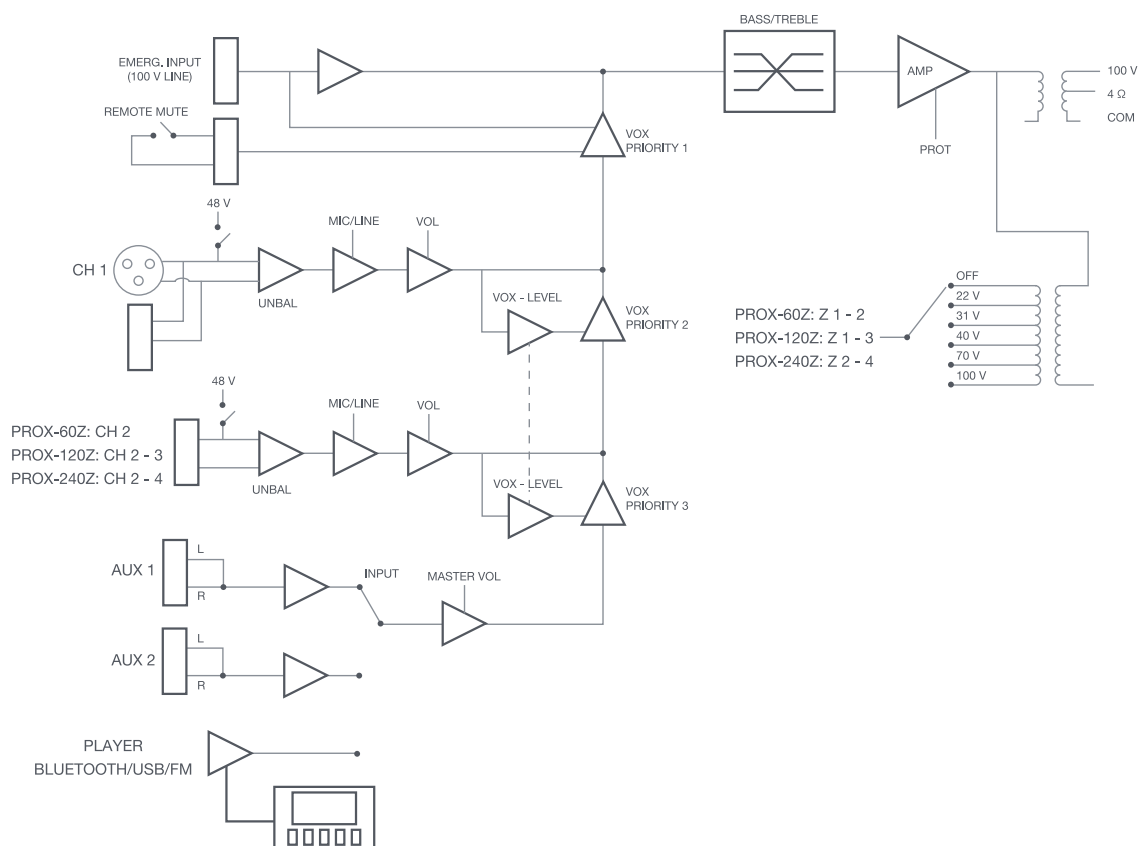

Amplia la información de los productos en:
<https://fonestar.com/es/PROX-240Z>